

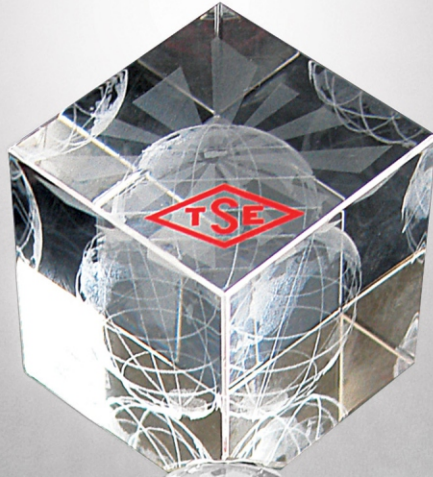

2014



TÜRK
STANDARTLARI
ENSTİTÜSÜ

2013 ALTIN KALITE ÖDÜLÜ
GOLD QUALITY AWARD

Türkiye'nin
ilk ve tek
TSE Belgeli
Anahtarları

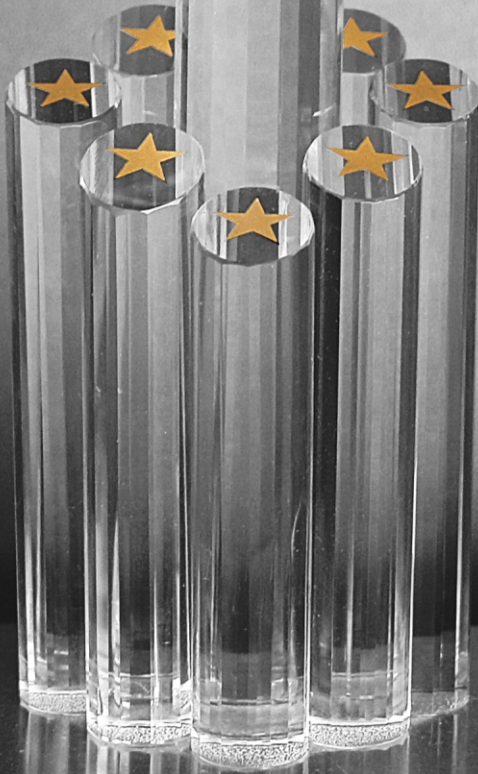



Kalite Ödülü 2013
GÜLER ANAHTAR VE KİLİT SANAYİ KOLLEKTİF MEHMET GÜLER VE OĞULLARI
1993 senesinden bu yana TSE Belgeli olması onuruna...
Mehmet HÜSREV
TSE Marmara Bölge Koordinatörü
Hulusi ŞENTÜRK
TSE Başkanı

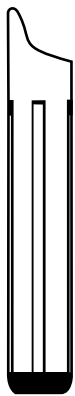

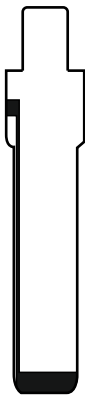

HYN 8 KTY



HU 8K



TAT 1K



FOT 3K



VLV 3K



NS 2KT

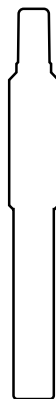

GT 17K

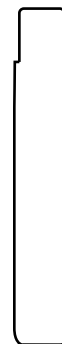

VA 2KS



DAC 3K



HU 66K



HU 67K

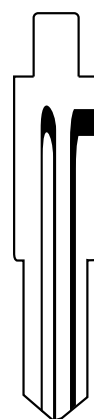

DWO 4K

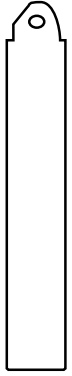

KIA 9KT



MIT 11K



NE 3KG



NE 72KS

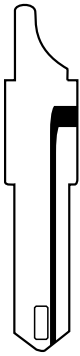

NE 72KT



NE 74KT

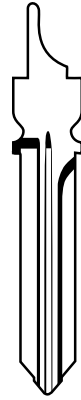

DAC 3KT

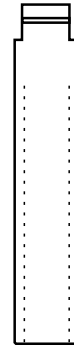

HU 83KS

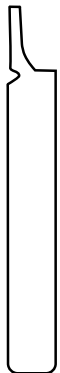

HU 44KT

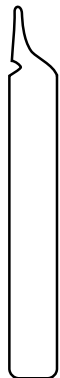

HU 66KT



NE 2KG

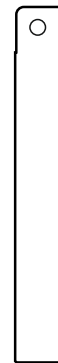

HU 60KD



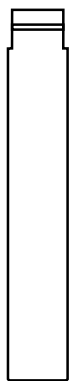

HYN 14K



HYN 1SK



HYN 4SK

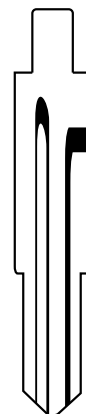

HYN 6KK

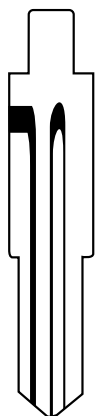

DWO 4SK



GSK 20SK



HYN 6SKK

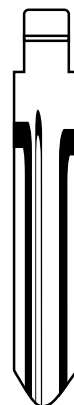

TOY 43SK



BMC 2K

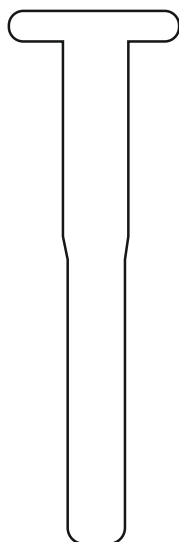

FOT 1KT



ARO 1K

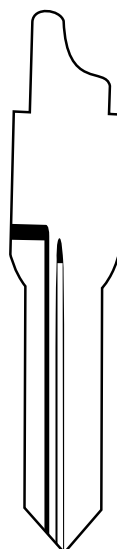

DAC 2KT

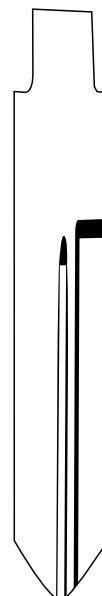

CY 20K



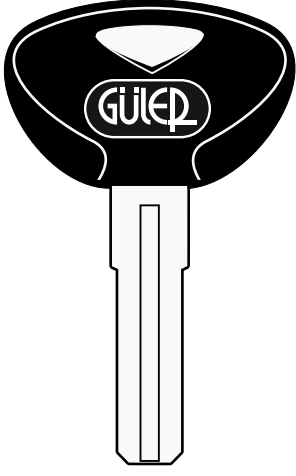

BW 1TPO

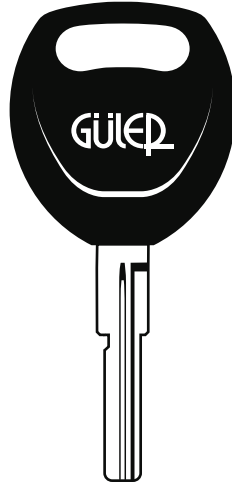

CL 1sP

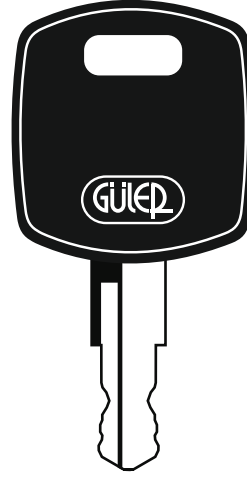

JB 1TPO

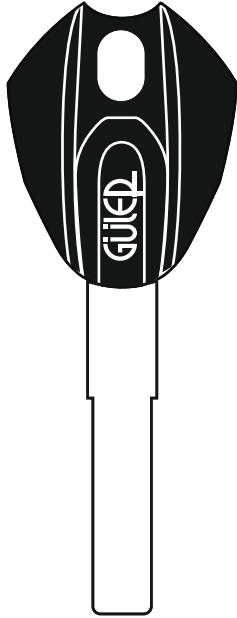

DCT- 2TPO

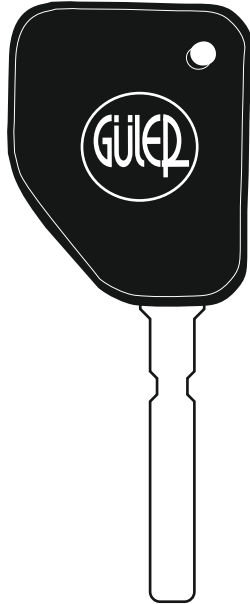

VLV 2TPO

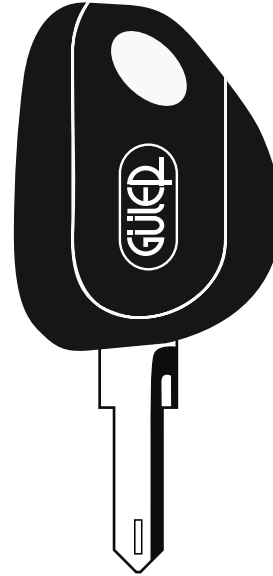

DAF 1 TPO

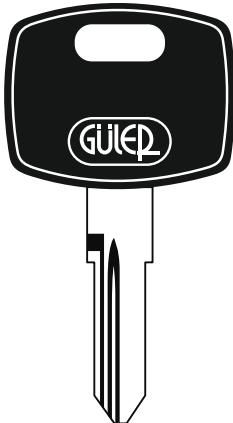

ET 1P

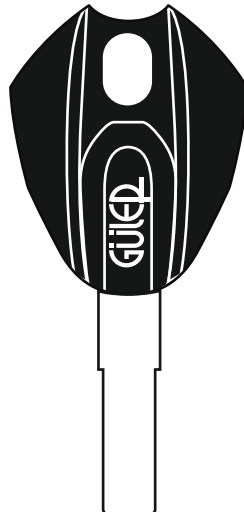

MK 3P



MK 2 P



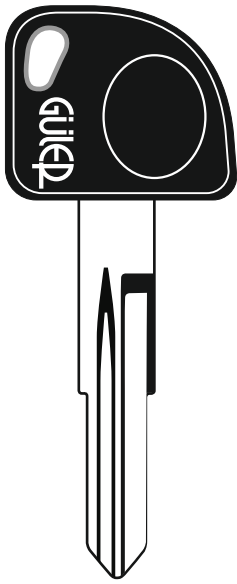

DWO 8P

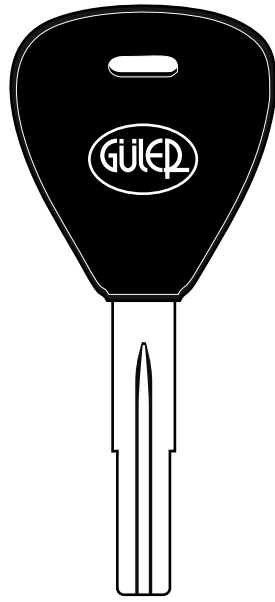

KU 1P

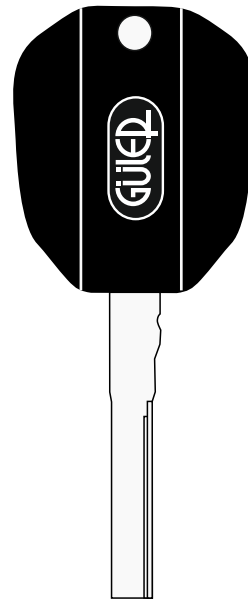

HU 42P

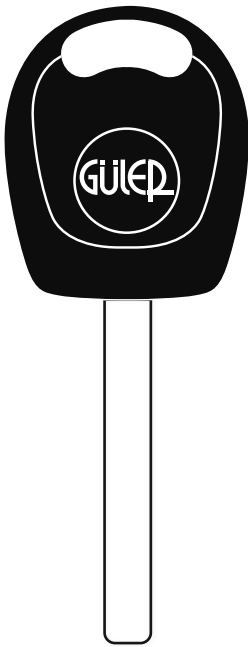

GHU - 10 TPO

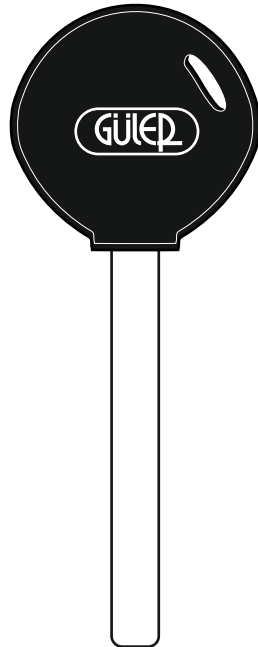

ARO 1P

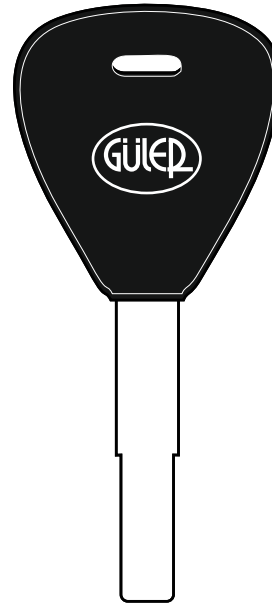

KU 4P

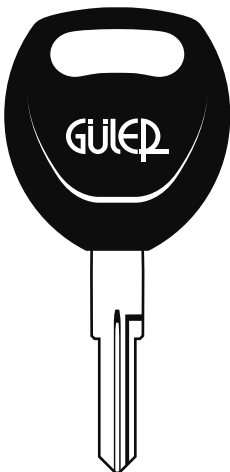

BFT 1P

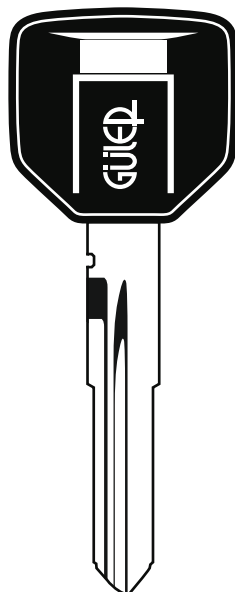

MIT 7STPO

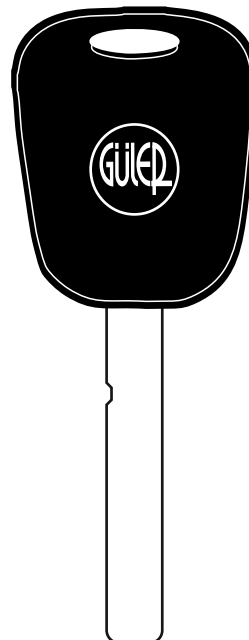

GVA- 2TPO



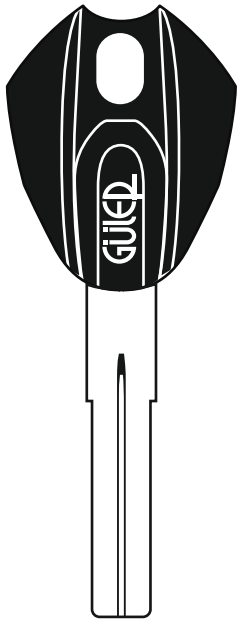

DCT- 1TPO

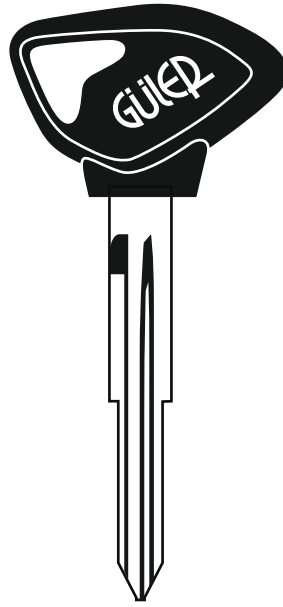

SZ 3SP

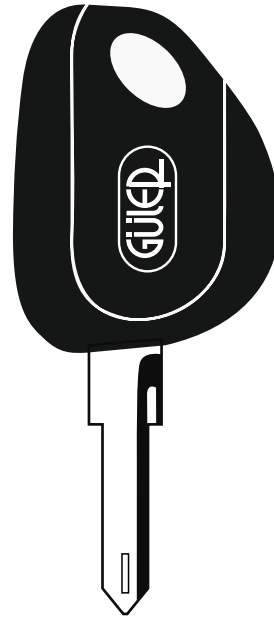

GNE 60TPO

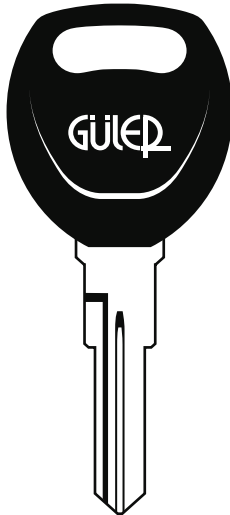

OTK 1SP

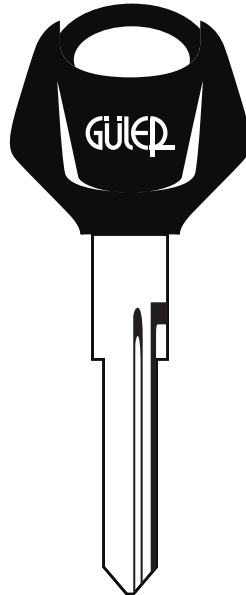

YH 60P

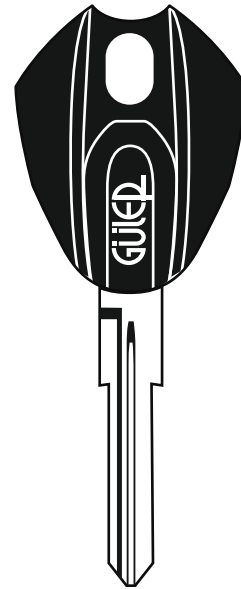

HR 1SP

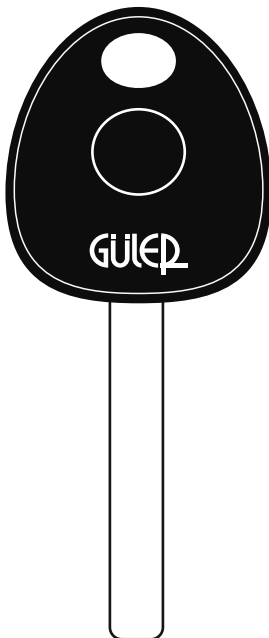

KIA 9 TPO

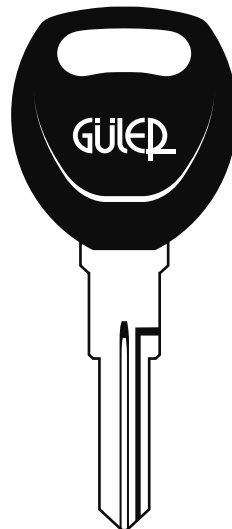

OTK 1P

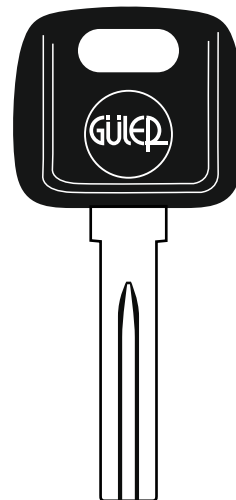

VLV 3TPO



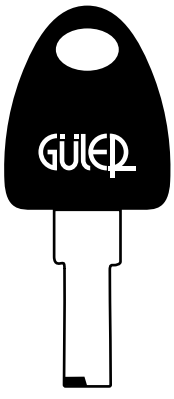

KN 1BP

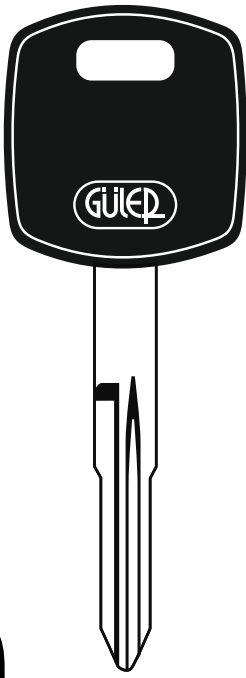

SZ 3STPO

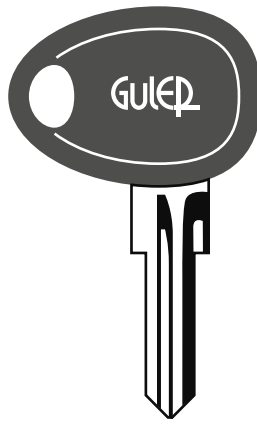

JR 1P

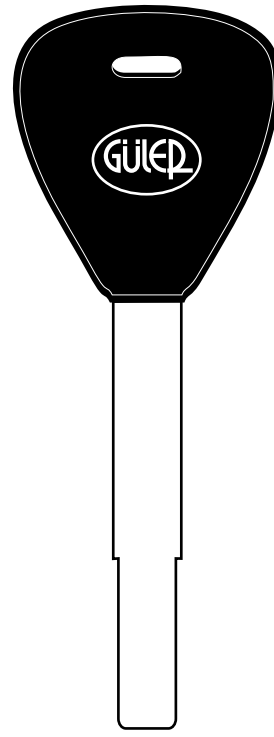

KU 3P

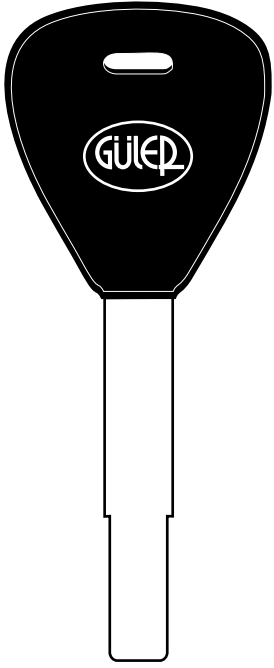

KU 2P

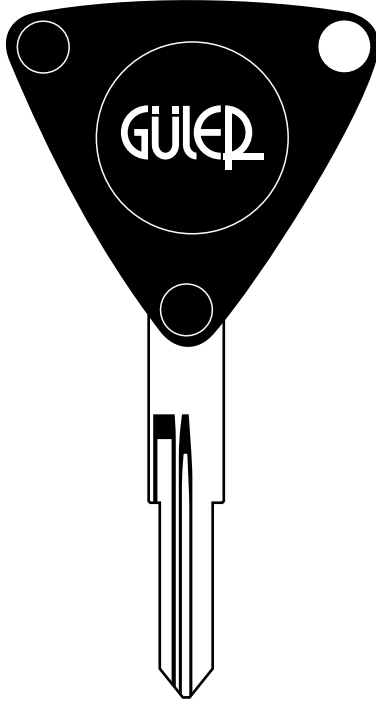

ZD 40P



VL 1P

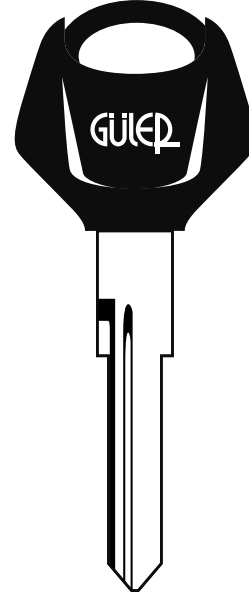

YH 60SP

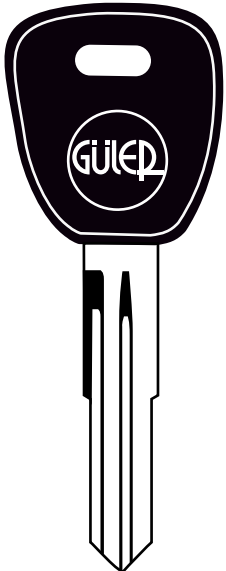

HON 6TPO

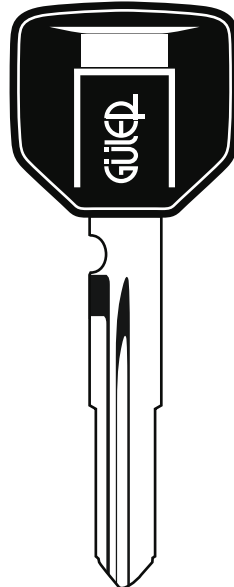

MIT 7STPO



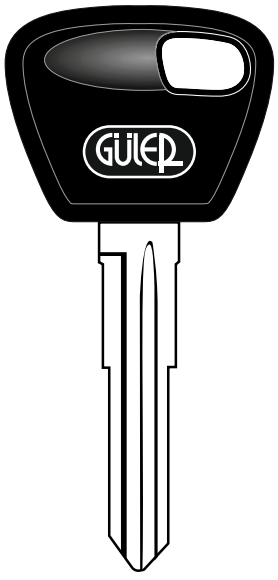

MAZ 16BP

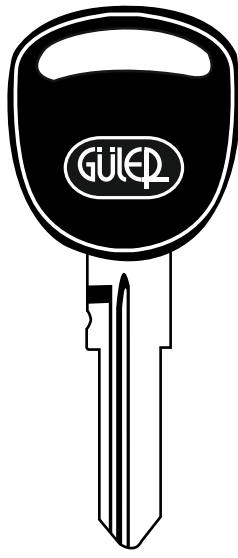

MKR - 1P

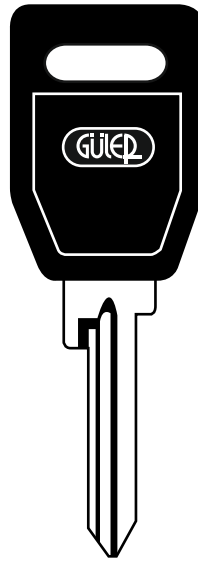

GSK 22 RP

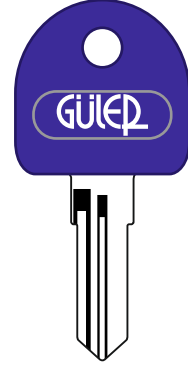

KLK 1SP

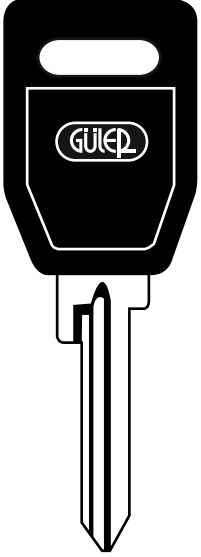

GSK 20 RP

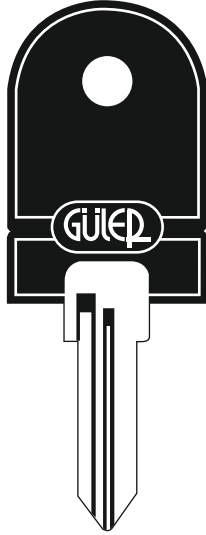

GYG 1RP

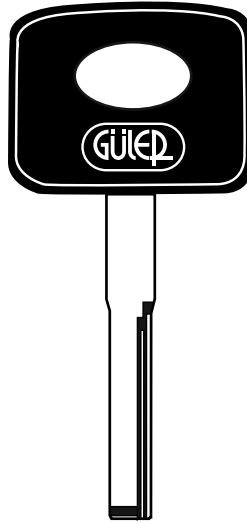

OJ 1SP

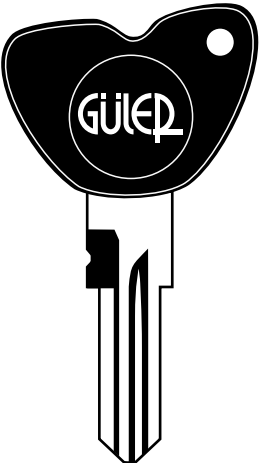

GT 15 RTPO



HU 10 K

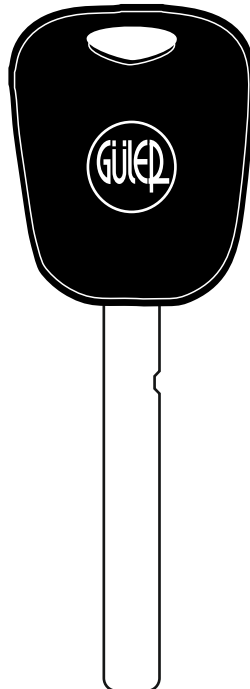

KIA 10 TPO

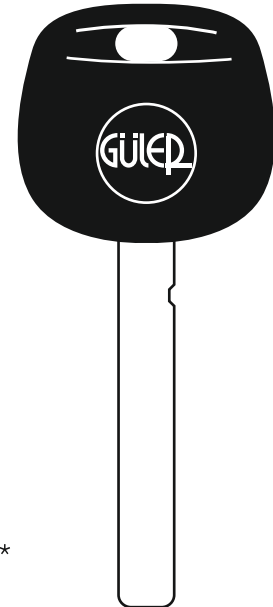

TOY 48 TPO

*

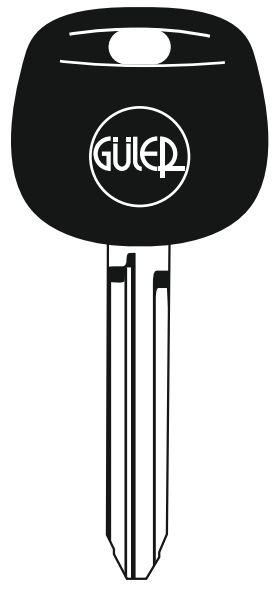

TOY 43STPO

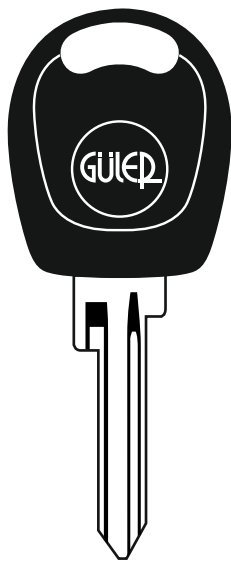

GSK 22 STPO

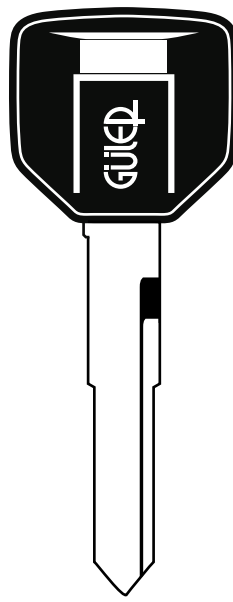

MIT 3TPO

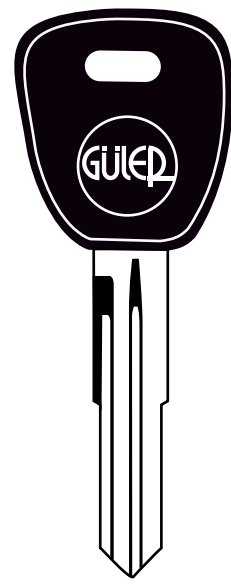

GHON 6STPO

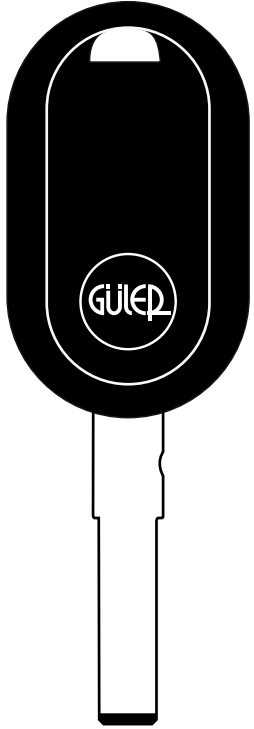

GT 17 TPO

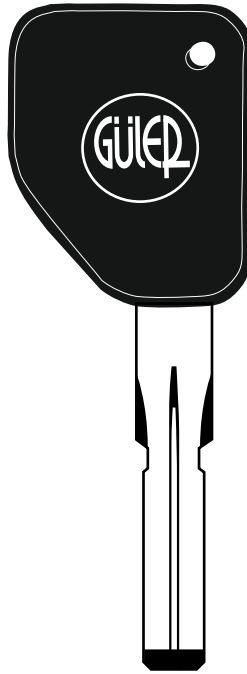

VLV 1TPO

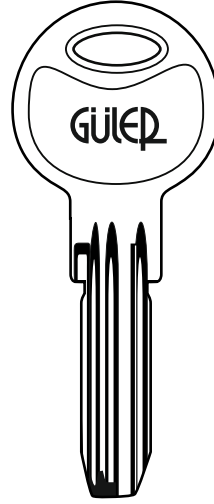

KA 12 BP

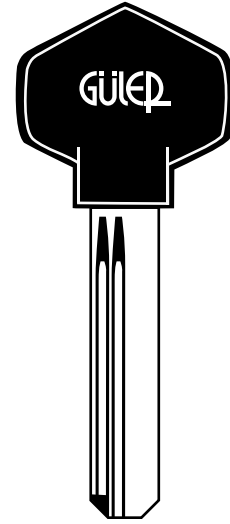

TAY - 1P

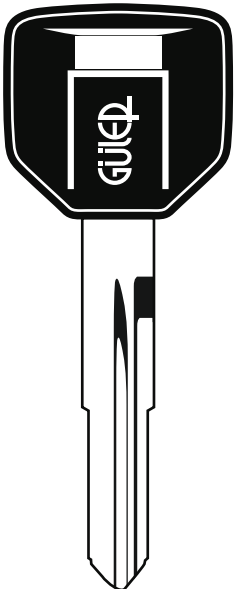

MIT 7TPO

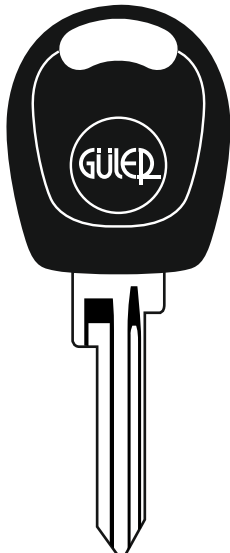

GSK 20 STPO

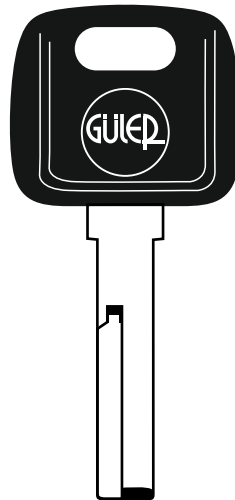

GHU 56 STPO

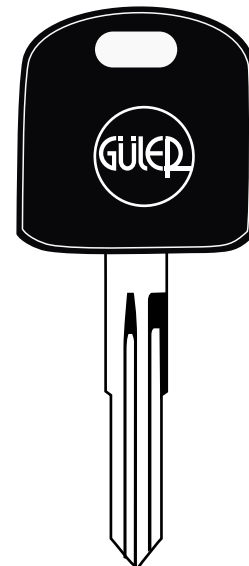

GNE 75TPO

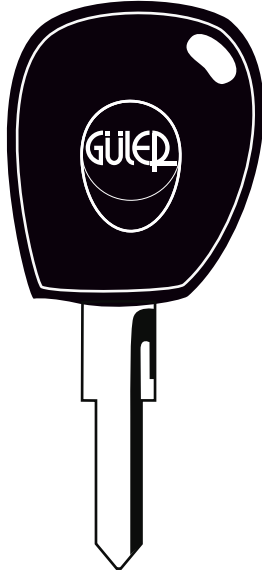

GNE 76TPO

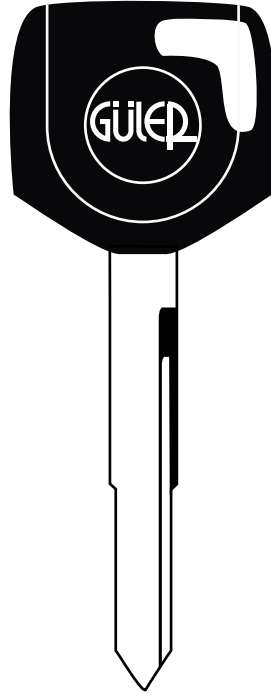

HON 70 TPO

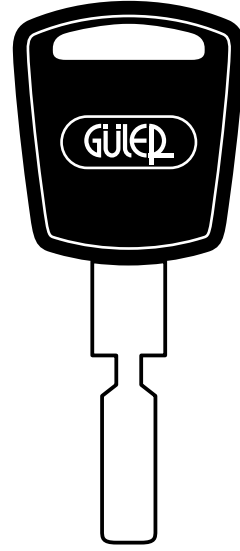

HU 71AP

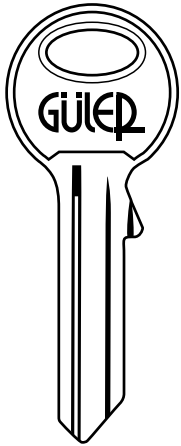

TSN 6U

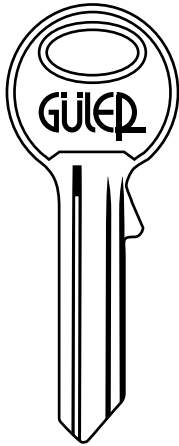

TSN 6SU

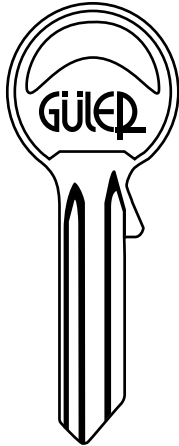

UN-7L

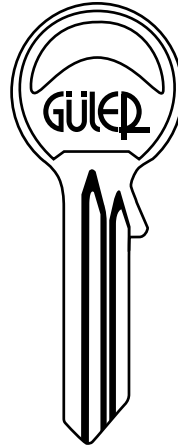

UN-7SL

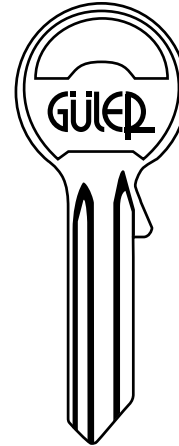

UN-4L

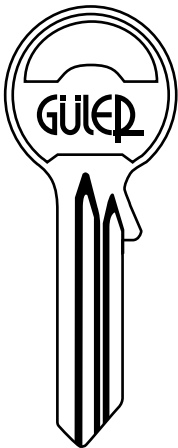

UN-4SL

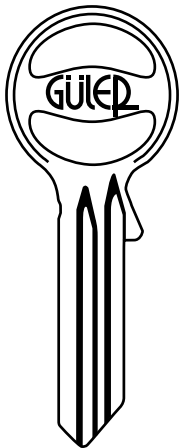

YU-15

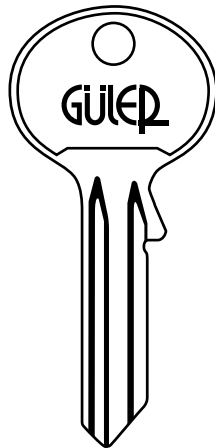

HOK 1E

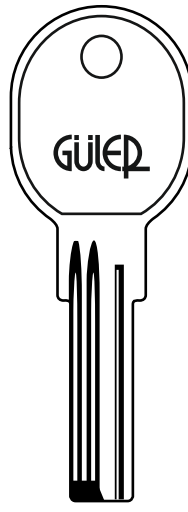

STL6B

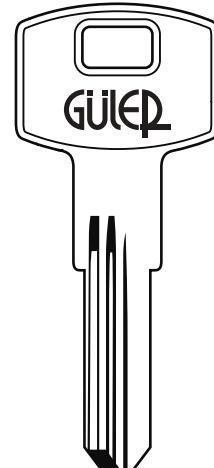

SE6B



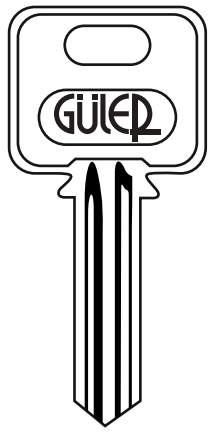

HOK 8

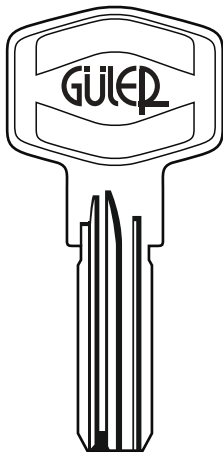

YMK 1B

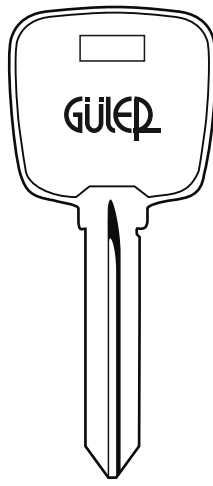

ARC2S

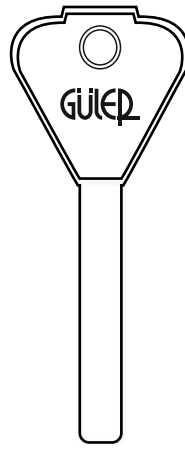

TL 10

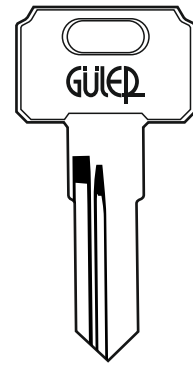

EMK-2

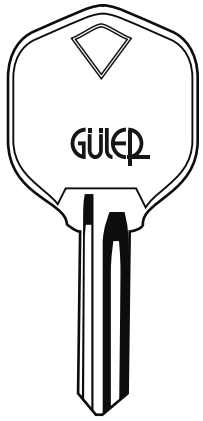

EZS 1

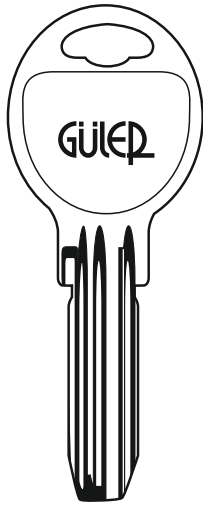

K23B

AKS 1P

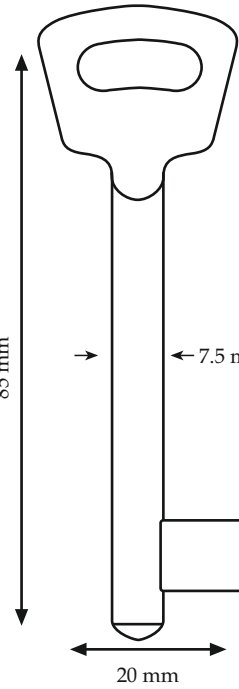
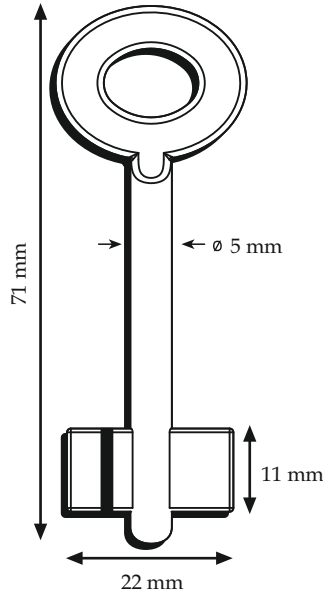

İTO EXTRA

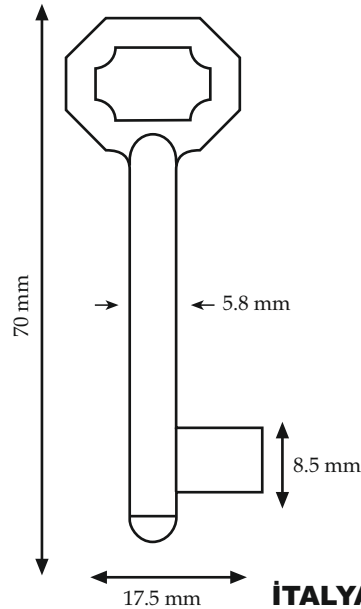
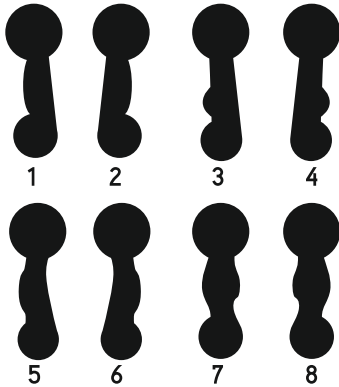

İTALYAN ODA

